

4.0A ULTRASOFT RECOVERY BRIDGE RECTIFIER
Reverse Voltage – 600 to 1000 V
Forward Current – 4.0A

FEATURES

- ◆Ultrasoft recovery
- ◆LOW I_{RRM}, LOW V_F, LOW V_{RRM}
- ◆Glass Passivated Chip Junction
- ◆Special frame design for heat dissipation
- ◆Lead free in comply with EU RoHS 2011/65/EU directives



BENEFITS

- ◆Reduced EMI
- ◆Reduced Power loss and switching transistor
- ◆Reduced snubbing

MECHANICAL DATA

- ◆Case: GBU
- ◆Terminals: Solderable per MIL-STD-750, Method 2026
- ◆Approx. Weight: 3.9g /0.138oz

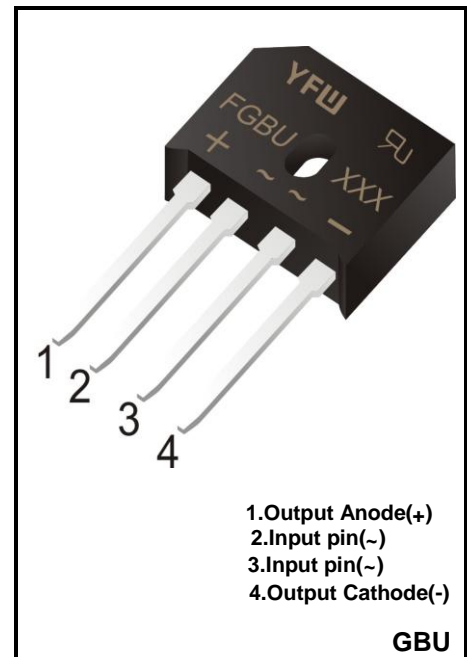

Maximum Ratings and Electrical characteristics

Ratings at 25 °C ambient temperature unless otherwise specified.

Single phase half-wave 60 Hz, resistive or inductive load, for capacitive load current derate by 20 %.

Parameter	Symbols	FGBU406	FGBU408	FGBU410	Units
Maximum Repetitive Peak Reverse Voltage	V _{RRM}	600	800	1000	V
Maximum RMS voltage	V _{RMS}	420	560	700	V
Maximum DC Blocking Voltage	V _{DC}	600	800	1000	V
Average Rectified Output Current	I _o	4.0			A
Reverse Recovery Time.IF=0.5A,IR=1A,IRR=0.25A	T _{rr}	10			uS
Peak Forward Surge Current 8.3 ms Single Half Sine-Wave Superimposed on Rated Load(JEDEC method)	I _{FSM}	110			A
I ² t Rating for Fusing(1ms≤t≤10ms)	I ² t	95			A ² S
Maximum Forward Voltage at 2.0 A	V _F	1.0			V
Maximum DC Reverse Current at Rated DC Blocking Voltage	I _R	5 100			uA
Typical Junction Capacitance (Note1)	C _j	50			pF
Operating and Storage Temperature Range	T _j , T _{stg}	-55 ~ +175			°C

Note: 1. Measured at 1MHz and applied reverse voltage of 4 V D.C.

2. Mounted on glass epoxy PC board with 4×1.5"×1.5" (3.81×3.81 cm) copper pad.

RATINGS AND CHARACTERISTICS CURVES (TA = 25 °C unless otherwise noted)

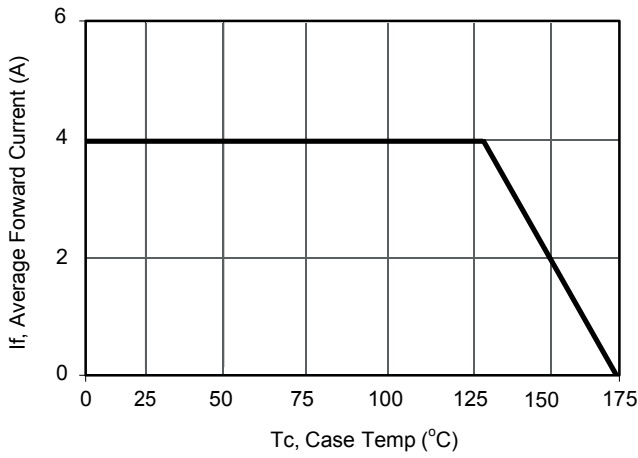

Current Derating, Case

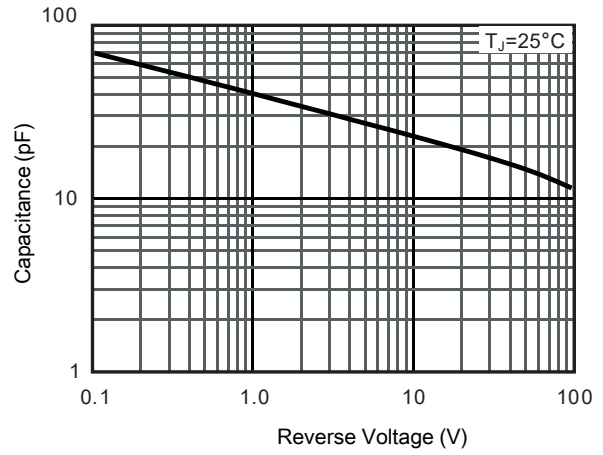

Typical Junction Capacitance

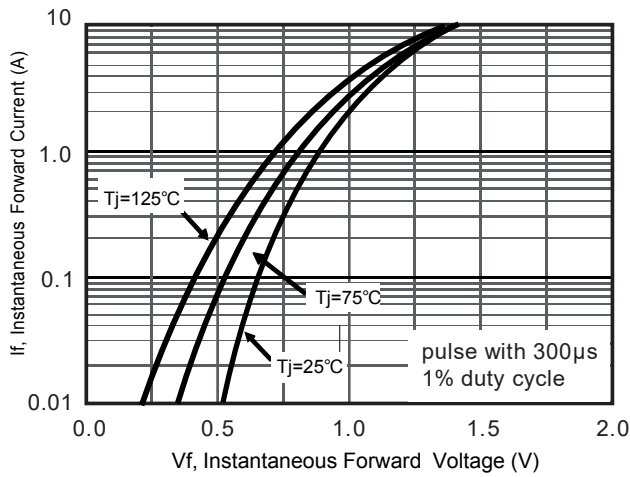

Typical Forward Voltage

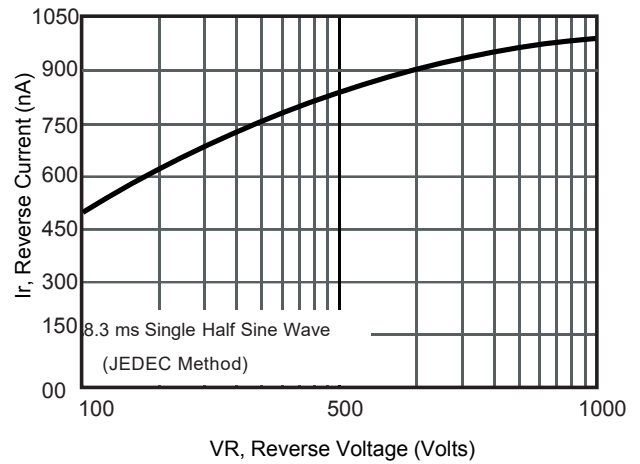

Typical Reverse Current

Package Outline

GBU

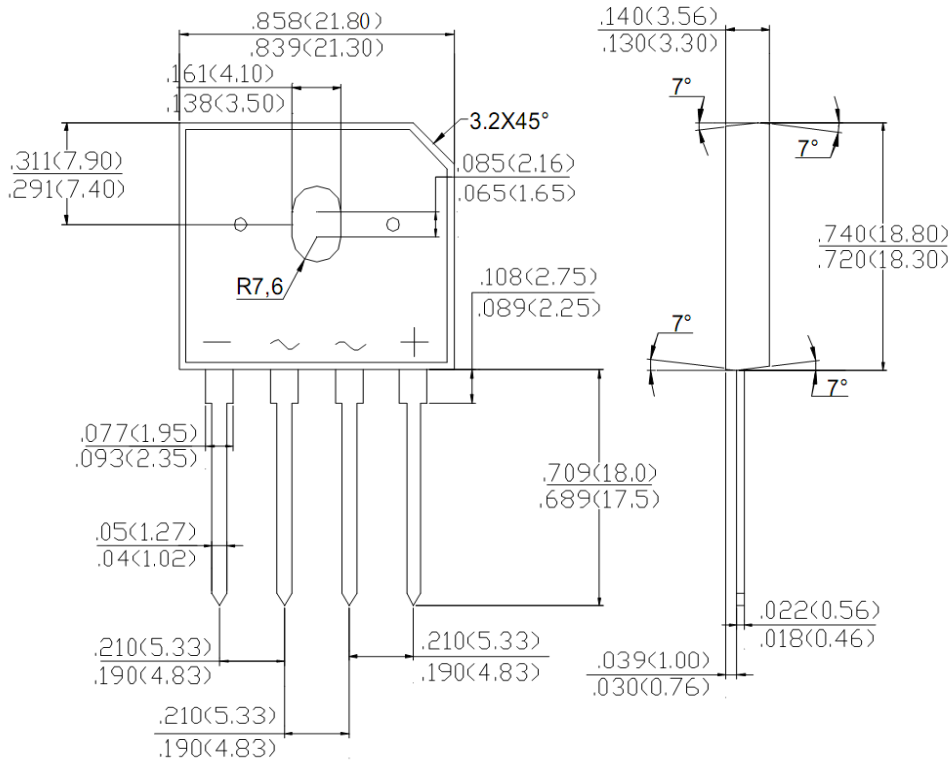

Summary of Packing Options

Package	Packing Description	Packing Quantity	Industry Standard
GBU	BOX	350	EIA-481-1