

Features

- Low Offset Voltage: 1uV
- Input Offset Drift: 0.03 μ V/ $^{\circ}$ C
- High Gain Bandwidth Product: 1.6MHz
- Rail-to-Rail Input and Output
- High Gain, CMRR, PSRR:130dB
- High Slew Rate: 0.7V/ μ s
- Low Noise: 1.3uVp-p (0.01~10Hz)
- Low Power Consumption: The typical values for both CBM8538 and CBM8539 are 360 μ A
- Overload Recovery Time:2us
- Low Supply Voltage: +2.7 V to +5.5 V
- No External Capacitors Required
- Extended Temperature: -40 $^{\circ}$ C to +125 $^{\circ}$ C

Application

- Temperature Sensors
- Medical/Industrial Instrumentation
- Pressure Sensors
- Battery-Powered Instrumentation
- Active Filtering
- Weight Scale Sensor
- Strain Gage Amplifiers
- Power Converter/Inverter

Description

The CBM8538, CBM8539 series of CMOS operational amplifiers use auto-zero techniques to simultaneously provide very low offset voltage (5 μ V max) and near-zero drift over time and temperature. This family of amplifiers has ultralow noise, offset and power.

This miniature, high-precision operational amplifiers offer high input impedance and rail-to-rail input and rail-to-rail output swing. With high gain-bandwidth product of 1.6MHz and slew rate of 0.7V/ μ s.

Single or dual supplies as low as +2.7V (\pm 1.35V) and up to +5.5V (\pm 2.5V) may be used.

The CBM8538/CBM8539 are specified for the extended industrial and automotive temperature range (-40 $^{\circ}$ C to 125 $^{\circ}$ C). The CBM8538 single amplifier is available in 5-lead SOT23, 8-lead MSOP and 8-lead SOIC packages, The CBM8539 dual amplifier is available in 8-lead SOIC and 8-lead MSOP narrow surface mount packages.

Catalog

Features.....	1
Application.....	1
Description.....	1
Catalog.....	2
Pin Configurations.....	3
Electrical Characteristics.....	4
Typical Characteristics.....	7
Application Notes.....	10
Operating Voltage.....	10
Layout Guidelines.....	10
Package Outline Dimensions.....	11
SOT23-5.....	11
MSOP-8.....	12
SOIC-8(SOP8).....	13
Package/Ordering Information.....	14

Pin Configurations

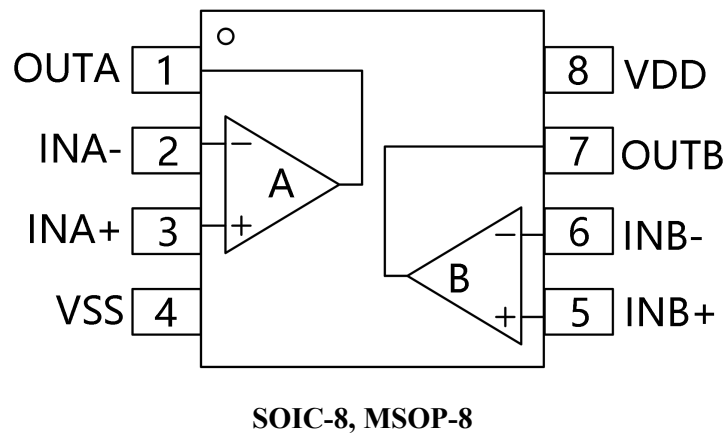
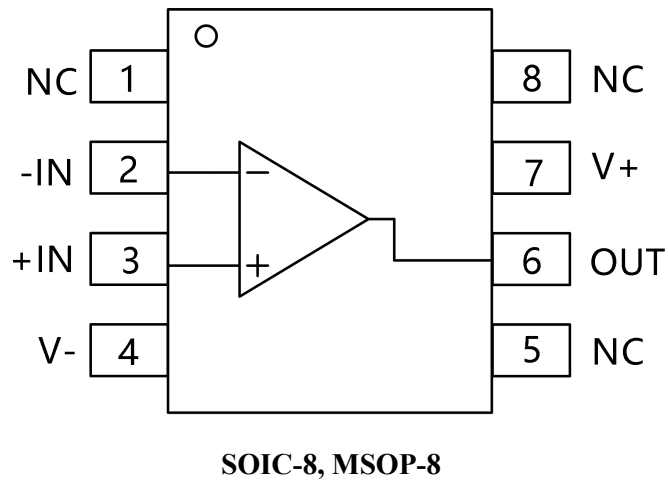
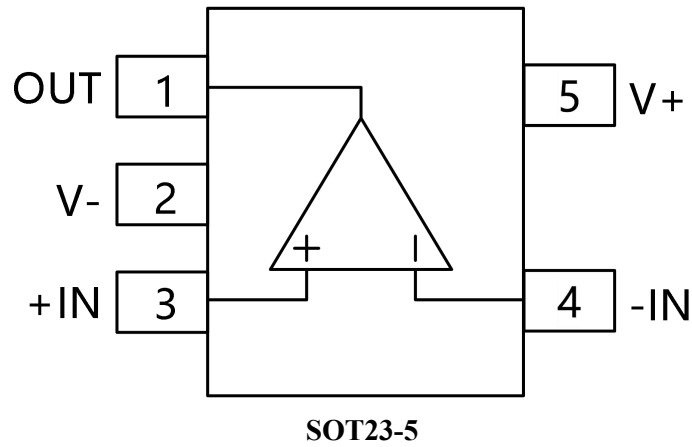

NC = No connect

Electrical Characteristics

- Supply Voltage, V+ to V- 6.0V
- Input Terminals, Voltage ⁽²⁾ - 0.5 to (V+) + 0.5V
 Current ⁽²⁾ ±10mA
- Storage Temperature -65°C to +150°C
- Operating Temperature -40°C to +125°C
- Junction Temperature -65°C to +150°C
- Package Thermal Resistance @ T_A = +25°C
- SOT23-5, SOT23-6 200°C/W
- MSOP-10, SOIC-8 150°C/W
- SOIC-14, TSSOP-14 100°C/W
- Lead Temperature (Soldering, 10s) 260°C
- ESD Susceptibility
- HBM 5000V
- MM 400V

1. Stresses above these ratings may cause permanent damage. Exposure to absolute maximum conditions for extended periods may degrade device reliability. These are stress ratings only, and functional operation of the device at these or any other conditions beyond those specified is not implied.

2. Input terminals are diode-clamped to the power-supply rails. Input signals that can swing more than 0.5V beyond the supply rails should be current-limited to 10mA or less.

Electrical Characteristics

Boldface limits apply over the specified temperature range, $T_A = -40^{\circ}\text{C}$ to $+125^{\circ}\text{C}$.

(At $T_A = +25^{\circ}\text{C}$, $V_S = 5\text{V}$, $R_L = 10\text{k}\Omega$ connected to $V_S/2$, and $V_{\text{OUT}} = V_S/2$, unless otherwise noted.)

PARAMETER	CONDITION	CBM8538, CBM8539			
		MIN	TYP	MAX	UNIT
OFFSET VOLTAGE					
Input Offset Voltage (V_{OS})	$V_{\text{CM}} = V_S/2$		1	5	μV
VS Temperature (dV_{OS}/dT)			0.005	0.05	$\mu\text{V}/^{\circ}\text{C}$
VS Power Supply (PSRR)	$V_S = +2.5\text{V}$ to $+5.5\text{V}$, $V_{\text{CM}} = 0$	110	130		dB
Channel Separation, dc			0.1		$\mu\text{V}/\text{V}$
INPUT BIAS CURRENT					
Input Bias Current (I_B)	$V_{\text{CM}} = V_S/2$		50		pA
Input Offset Current (I_{OS})			10		pA
NOISE PERFORMANCE					
Input Voltage Noise ($e_{\text{n,p-p}}$)	$f=0.01\text{Hz}$ to 10Hz		1.3		μVpp
Input Voltage Noise ($e_{\text{n,p-p}}$)	$f=0.01\text{Hz}$ to 1Hz		0.4		μVpp
Input Voltage Noise Density (e_n)	$f=1\text{KHz}$		60		$\text{nV}/\sqrt{\text{Hz}}$
Input Current Noise Density (i_n)	$f=10\text{Hz}$		8		$\text{fA}/\sqrt{\text{Hz}}$
INPUT VOLTAGE RANGE					
Common-Mode Voltage Range (V_{CM})		(V-)-0.1		(V+)+0.1	V
Common-Mode Rejection Ratio (CMRR)	$(V-) - 0.1\text{V} < V_{\text{CM}} < (V+) + 0.1\text{V}$	110	130		dB
INPUT CAPACITANCE					
Differential			1		pF
Common-Mode			5		pF
OPEN-LOOP GAIN					
Open-Loop Voltage Gain (A_{OL})	$R_L=10\text{K}\Omega$, $V_O=0.3\text{V}$ to 4.7V , $-40^{\circ}\text{C}\sim 125^{\circ}\text{C}$	110	130		dB
DYNAMIC PERFORMANCE					
Slew Rate (SR)	$G=+1$		0.7		$\text{V}/\mu\text{s}$
Gain-Bandwidth Product (GBW)			1.6		MHz
Overload Recovery Time			2		μs
OUTPUT CHARACTERISTICS					

Output Voltage High (V_{OH})	$R_L=100\text{ K}\Omega$ to GND	4.99	4.998		V
	$R_L=10\text{ K}\Omega$ to GND	4.95	4.98		V
Output Voltage Low (V_{OL})	$R_L=100\text{ K}\Omega$ to V+		1	10	mV
	$R_L=10\text{ K}\Omega$ to V+		10	30	mV
Short-Circuit Current (I_{SC})			40		mA
POWER SUOOLY					
Operating Voltage Range		2.5		5.5	V
Quiescent Current (I_Q)			360	520	μ A
SHUTDOWN					
TOFF			2		μ s
TON			150		us
V_L (shutdown)		0		+0.8	V
V_H (amplifier is active)		0.75(V+)		V+	V
Input Bias Current of Enable Pin			50		pA
I_{QSD}			1	5	μ A

Typical Characteristics

At $T_A = +25^\circ\text{C}$, $V_S = 5\text{V}$, $R_L = 10\text{k}\Omega$ connected to $V_S/2$, $V_{OUT} = V_S/2$, unless otherwise noted.

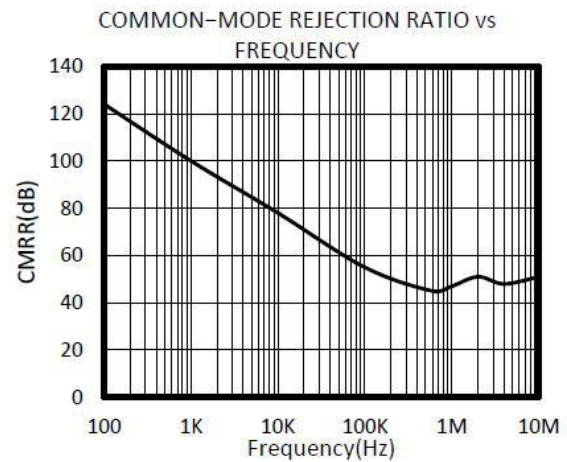
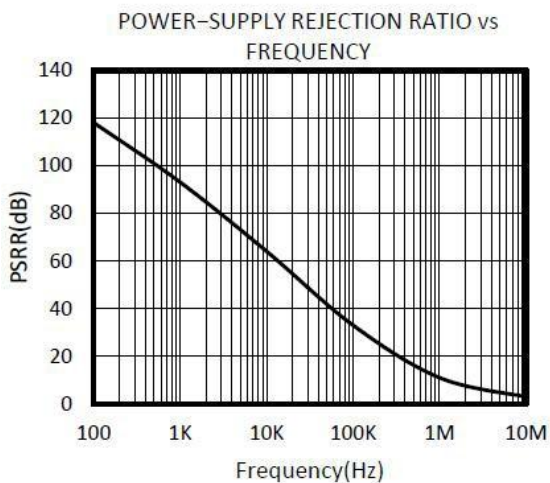
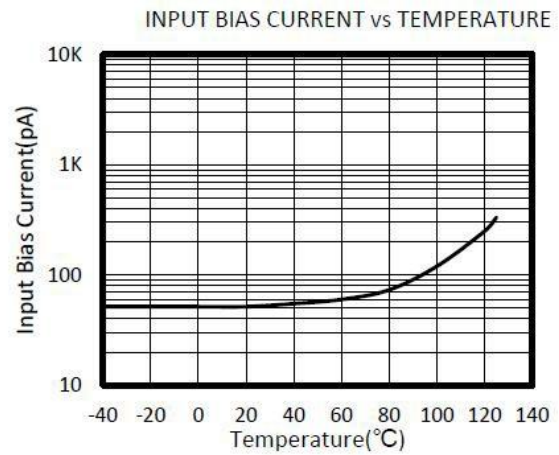
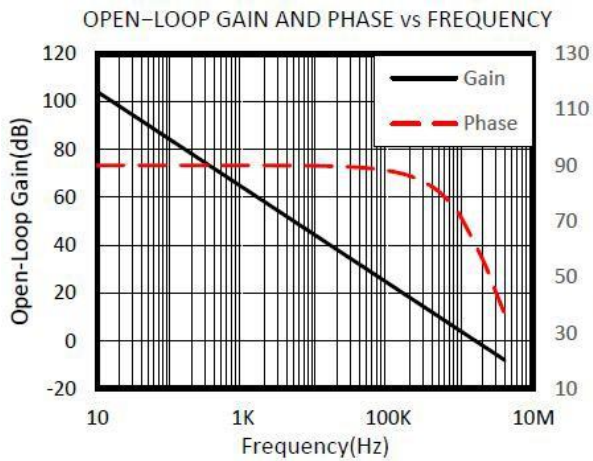
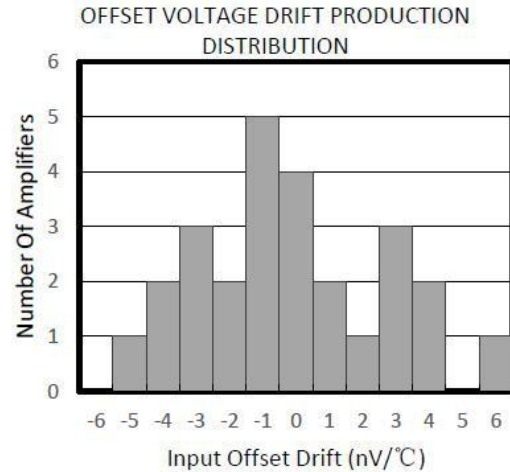
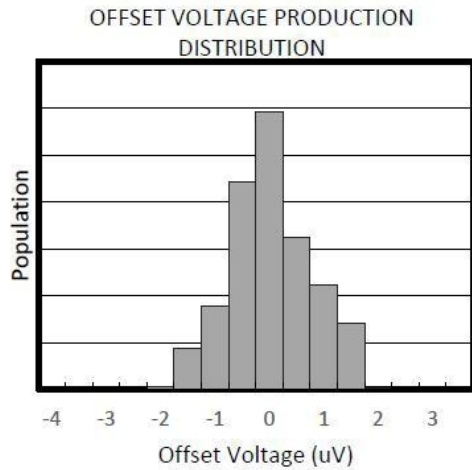

Typical Characteristics

AT $T_A = +25^\circ\text{C}$ $V_S = 5\text{V}$, $R_L = 10\text{ k}\Omega$ connected to $V_S/2$ and $V_{OUT} = V_S/2$, unless otherwise noted.

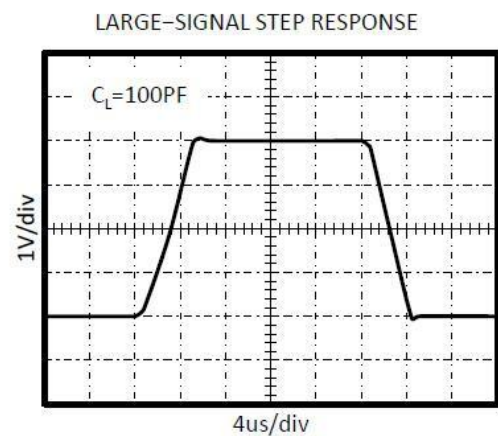
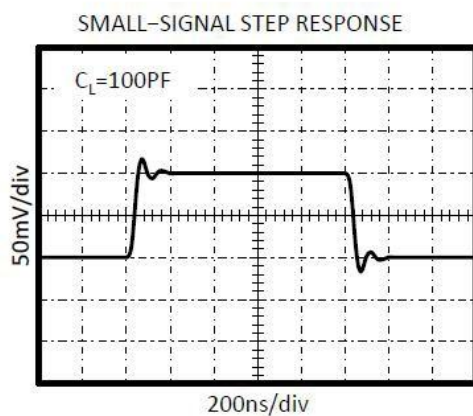
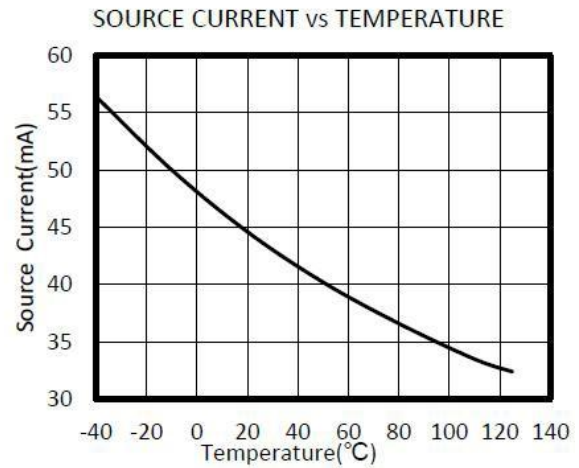
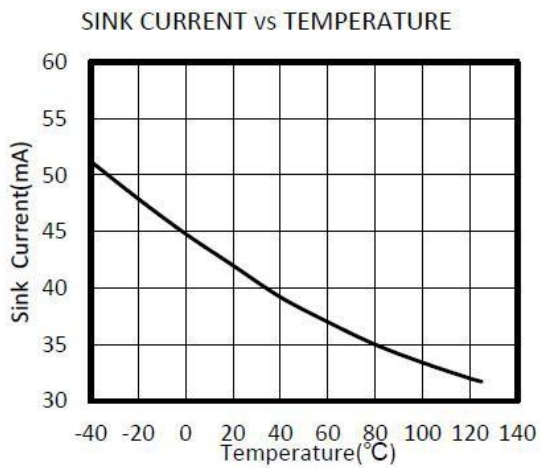
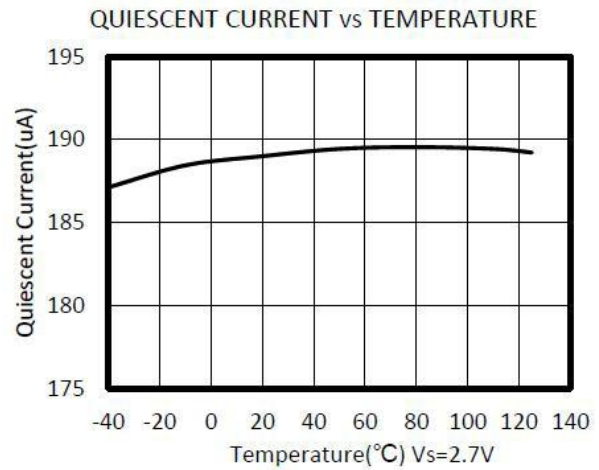
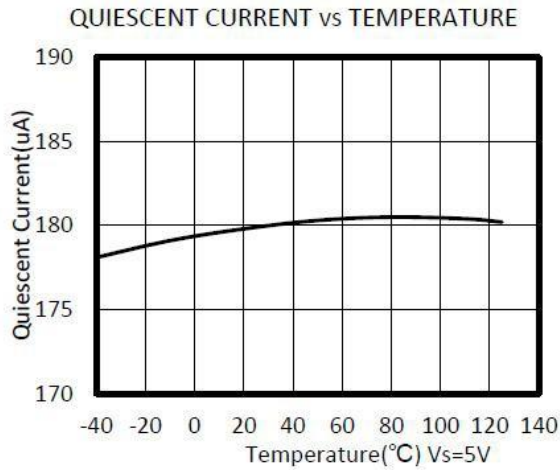

Typical Characteristics

At $T_A = +25^\circ\text{C}$, $V_S = 5\text{V}$, $R_L = 10\text{k}\Omega$ connected to $V_S/2$, $V_{OUT} = V_S/2$, unless otherwise noted.

POSITIVE OVERVOLTAGE RECOVERY

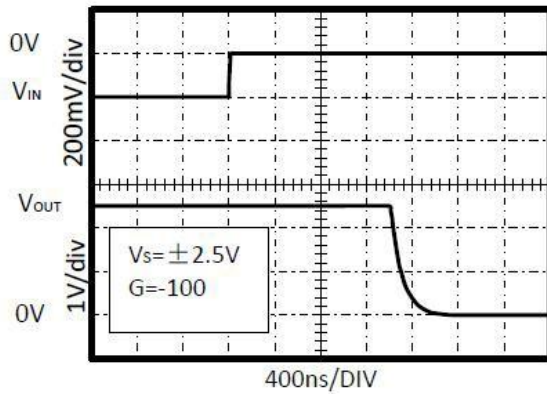

NEGATIVE OVERVOLTAGE RECOVERY

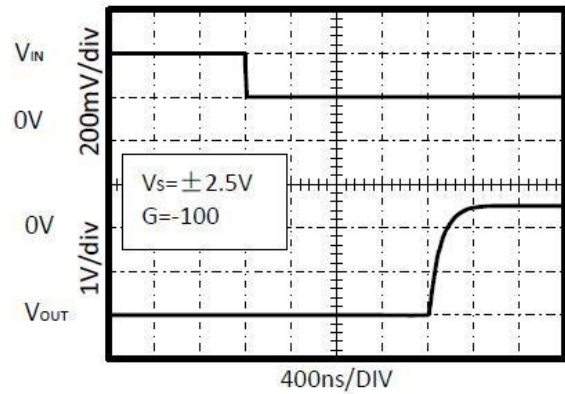

0.01Hz TO 10Hz NOISE AT $V_S = 5\text{V}$

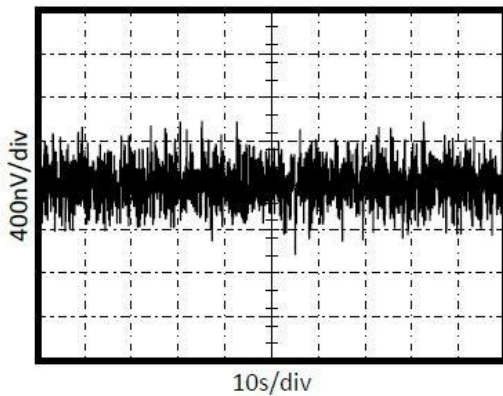

0.01Hz TO 10Hz NOISE AT $V_S = 2.7\text{V}$

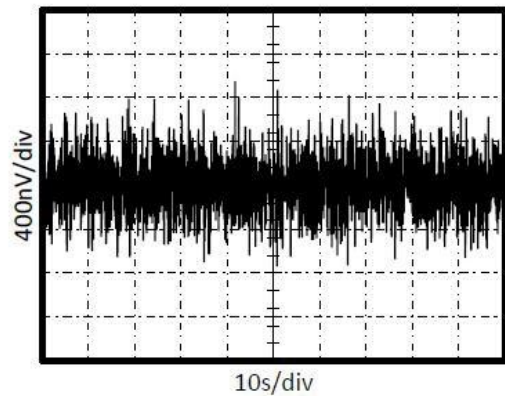

0.01Hz TO 1Hz NOISE AT $V_S = 5\text{V}$

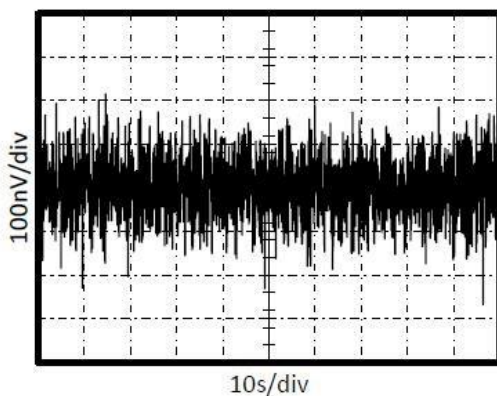

0.01Hz TO 1Hz NOISE AT $V_S = 2.7\text{V}$

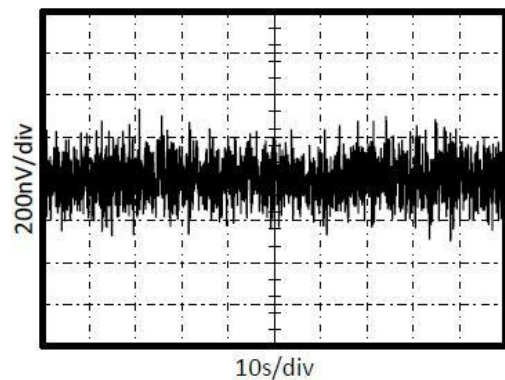

Application Notes

The CBM8538, CBM8539 series op amps are unity-gain stable and free from unexpected output phase reversal. They use auto-zeroing techniques to provide low offset voltage and very low drift over time and temperature.

Good layout practice mandates use of a $0.1\mu\text{F}$ capacitor placed closely across the supply pins.

For lowest offset voltage and precision performance, circuit layout and mechanical conditions should be optimized. Avoid temperature gradients that create thermoelectric (Seebeck) effects in thermocouple junctions formed from connecting dissimilar conductors. These thermally-generated potentials can be made to cancel by assuring that they are equal on both input terminals.

Use low thermoelectric-coefficient connections (avoid dissimilar metals).

Thermally isolate components from power supplies or other heat-sources.

Shield op amp and input circuitry from air currents, such as cooling fans.

Following these guidelines will reduce the likelihood of junctions being at different temperatures, which can cause thermoelectric voltages of $0.1\mu\text{V}/^\circ\text{C}$ or higher, depending on materials used.

Operating Voltage

The CBM8538, CBM8539 series op amps operate over a power-supply range of +2.5V to +5.5V ($\pm 1.25\text{V}$ to $\pm 2.75\text{V}$). Supply voltages higher than 7V (absolute maximum) can permanently damage the amplifier. Parameters that vary over supply voltage or temperature are shown in the Typical Characteristics section of this data sheet.

Layout Guidelines

Attention to good layout practices is always recommended. Keep traces short. When possible, use a PCB ground plane with surface-mount components placed as close to the device pins as possible. Place a $0.1\mu\text{F}$ capacitor closely across the supply pins.

These guidelines should be applied throughout the analog circuit to improve performance and provide benefits such as reducing the EMI (electromagnetic-interference) susceptibility.

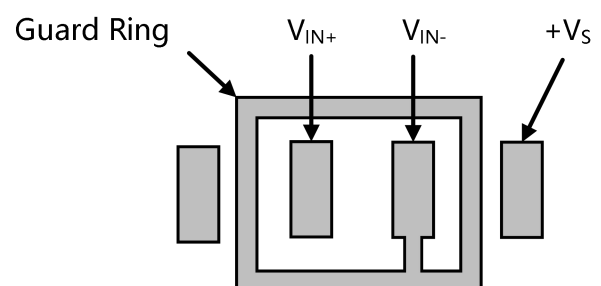
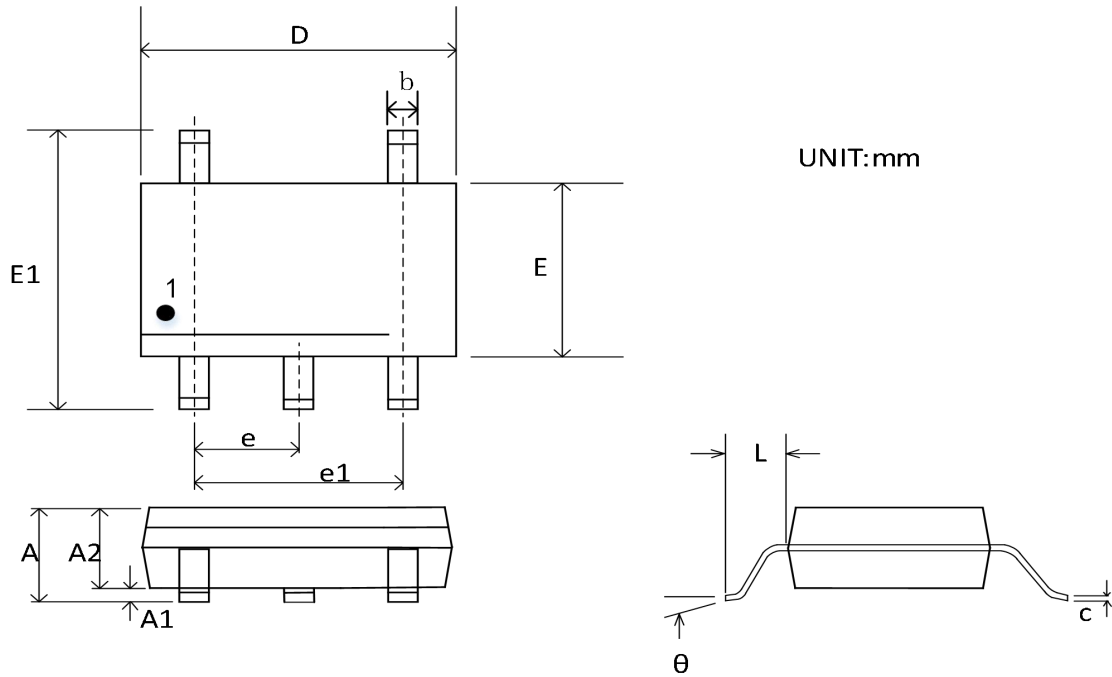

Figure 1. The Layout of Guard Ring

Package Outline Dimensions

SOT23-5



Symbol	Dimensions In Millimeters		Dimensions Inches	
	Min	Max	Min	Max
A	1.050	1.250	0.041	0.049
A1	0.000	0.100	0.000	0.004
A2	1.050	1.150	0.041	0.045
b	0.300	0.500	0.012	0.020
c	0.100	0.200	0.004	0.008
D	2.820	3.020	0.111	0.119
E	1.500	1.700	0.059	0.067
E1	2.650	2.950	0.104	0.116
e	0.950 BSC		0.037 BSC	
e1	1.800	2.000	0.071	0.079
L	0.300	0.600	0.012	0.024
θ	0°	8°	0°	8°

MSOP-8

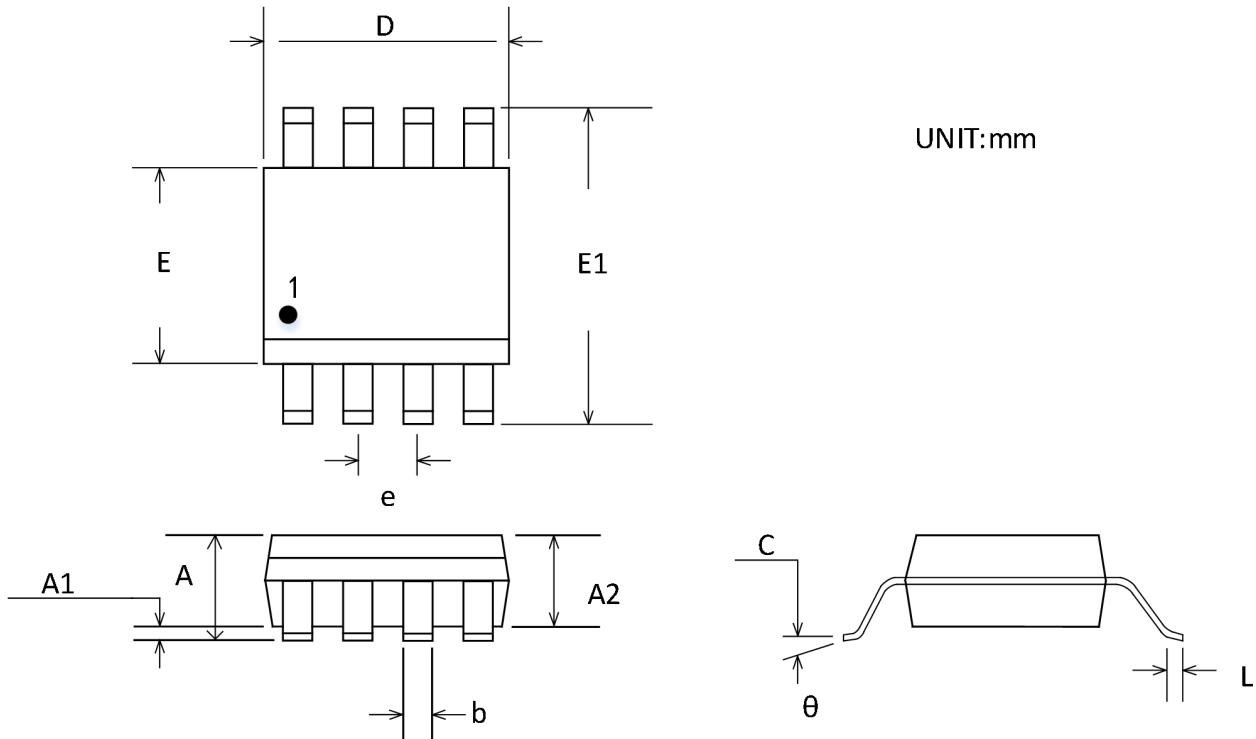

Symbol	Dimensions In Millimeters		Dimensions Inches	
	Min	Max	Min	Max
A	0.820	1.100	0.032	0.043
A1	0.020	0.150	0.001	0.006
A2	0.750	0.950	0.030	0.037
b	0.250	0.380	0.010	0.015
c	0.090	0.230	0.004	0.009
D	2.900	3.100	0.114	0.122
E	2.900	3.100	0.114	0.122
E1	4.750	5.050	0.187	0.199
e	0.650 BSC		0.026 BSC	
L	0.400	0.800	0.016	0.031
θ	0°	6°	0°	6°

SOIC-8(SOP8)

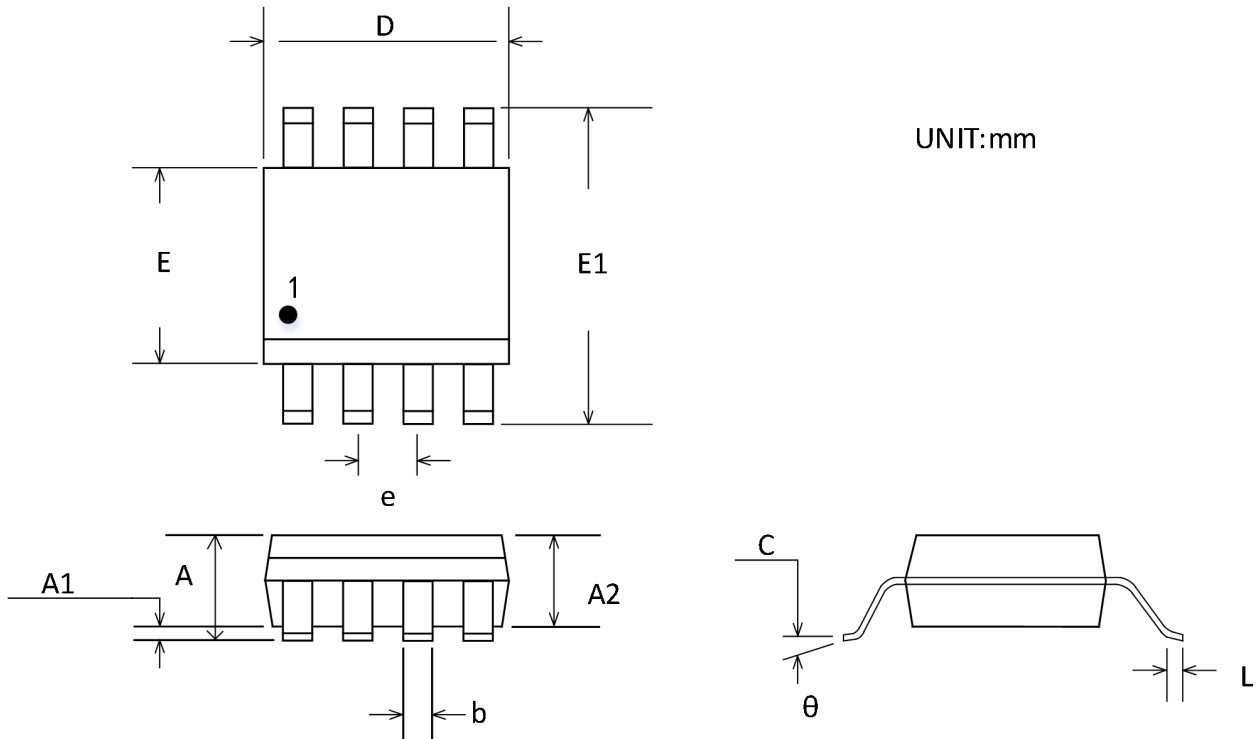

Symbol	Dimensions In Millimeters		Dimensions Inches	
	Min	Max	Min	Max
A	1.350	1.750	0.053	0.069
A1	0.100	0.250	0.004	0.010
A2	1.350	1.550	0.053	0.061
b	0.330	0.510	0.013	0.020
c	0.170	0.250	0.007	0.010
D	4.800	5.000	0.189	0.197
E	3.800	4.000	0.150	0.157
E1	5.800	6.200	0.228	0.244
e	1.270 BSC		0.050 BSC	
L	0.400	1.270	0.016	0.050
θ	0°	8°	0°	8°

Package/Ordering Information

ORDERING NUMBER	TEMPRANGE	PACKAGE	PAKEAGE MARKING	TRANSPOT MEDIA, QUANTILY
CBM8538AST5	-40°C~125°C	SOT23-5	8538	Tape and Reel, 3000
CBM8538AS8	-40°C~125°C	SOIC-8(SOP8)	CBM8538A	Tape and Reel, 2500
CBM8538AS8-RL	-40°C~125°C	SOIC-8(SOP8)	CBM8538A	Tape and Reel, 3000
CBM8538AS8-REEL	-40°C~125°C	SOIC-8(SOP8)	CBM8538A	Tape and Reel, 4000
CBM8538AMS8	-40°C~125°C	MSOP-8	ATE	Tape and Reel, 3000
CBM8539AS8	-40°C~125°C	SOIC-8(SOP8)	CBM8539A	Tape and Reel, 2500
CBM8539AS8-RL	-40°C~125°C	SOIC-8(SOP8)	CBM8539A	Tape and Reel, 3000
CBM8539AS8-REEL	-40°C~125°C	SOIC-8(SOP8)	CBM8539A	Tape and Reel, 4000
CBM8539AMS8	-40°C~125°C	MSOP-8	ATN	Tape and Reel, 3000