

### General Description

These devices are well suited for low voltage and battery powered applications where low in-line power loss and fast switching are required.

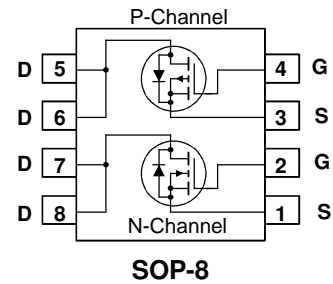

### Features

#### N-Channel

- $V_{DS}$  (V) = 30V
- $I_D$  = 7A ( $V_{GS}$  = 10V)
- $R_{DS(ON)}$  < 28m $\Omega$  ( $V_{GS}$  = 10V)
- $R_{DS(ON)}$  < 40m $\Omega$  ( $V_{GS}$  = 4.5V)

#### P-Channel

- $V_{DS}$  (V) = -30V
- $I_D$  = 5A ( $V_{GS}$  = -10V)
- $R_{DS(ON)}$  < 52m $\Omega$  ( $V_{GS}$  = -10V)
- $R_{DS(ON)}$  < 80m $\Omega$  ( $V_{GS}$  = -4.5V)

### Absolute Maximum Ratings $T_A = 25^\circ\text{C}$ unless otherwise noted

Symbol	Parameter	N-Channel	P-Channel	Units
$V_{DSS}$	Drain-Source Voltage	30	30	V
$V_{GSS}$	Gate-Source Voltage	$\pm 20$	$\pm 20$	V
$I_D$	Drain Current - Continuous (Note 1a)	7	-5	A
	- Pulsed	20	-20	
$P_D$	Power Dissipation for Dual Operation	2	2	W
	Power Dissipation for Single Operation (Note 1a)	1.6	1.6	
	(Note 1c)	0.9	0.9	
$E_{AS}$	Single Pulse Avalanche Energy (Note 3)	54	13	mJ
$T_J, T_{STG}$	Operating and Storage Junction Temperature Range	-55 to +150		$^\circ\text{C}$

### Thermal Characteristics

$R_{\theta JA}$	Thermal Resistance, Junction-to-Ambient (Note 1a)	78	$^\circ\text{C/W}$
$R_{\theta JC}$	Thermal Resistance, Junction-to-Case (Note 1)	40	$^\circ\text{C/W}$

**Electrical Characteristics**
 $T_A = 25^\circ\text{C}$  unless otherwise noted

Symbol	Parameter	Test Conditions	Type	Min	Typ	Max	Units
<b>Off Characteristics</b>							
$BV_{DSS}$	Drain-Source Breakdown Voltage	$V_{GS} = 0\text{ V}, I_D = 250\ \mu\text{A}$ $V_{GS} = 0\text{ V}, I_D = -250\ \mu\text{A}$	N-Ch P-Ch	30 -30			V
$\Delta BV_{DSS} / \Delta T_J$	Breakdown Voltage Temperature Coefficient	$I_D = 250\ \mu\text{A}$ , Referenced to $25^\circ\text{C}$ $I_D = -250\ \mu\text{A}$ , Referenced to $25^\circ\text{C}$	N-Ch P-Ch		25 -23		mV/ $^\circ\text{C}$
$I_{DSS}$	Zero Gate Voltage Drain Current	$V_{DS} = 24\text{ V}, V_{GS} = 0\text{ V}$ $V_{DS} = -24\text{ V}, V_{GS} = 0\text{ V}$	N-Ch P-Ch			1 -1	$\mu\text{A}$
$I_{GSSF}$	Gate-Body Leakage, Forward	$V_{GS} = 20\text{ V}, V_{DS} = 0\text{ V}$	All			100	nA
$I_{GSSR}$	Gate-Body Leakage, Reverse	$V_{GS} = -20\text{ V}, V_{DS} = 0\text{ V}$	All			-100	nA
<b>On Characteristics (Note 2)</b>							
$V_{GS(th)}$	Gate Threshold Voltage	$V_{DS} = V_{GS}, I_D = 250\ \mu\text{A}$ $V_{DS} = V_{GS}, I_D = -250\ \mu\text{A}$	N-Ch P-Ch	1 -1	1.9 -1.7	3 -3	V
$\Delta V_{GS(th)} / \Delta T_J$	Gate Threshold Voltage Temperature Coefficient	$I_D = 250\ \mu\text{A}$ , Referenced to $25^\circ\text{C}$ $I_D = -250\ \mu\text{A}$ , Referenced to $25^\circ\text{C}$	N-Ch P-Ch		-4.5 4.5		mV/ $^\circ\text{C}$
$R_{DS(on)}$	Static Drain-Source On-Resistance	$V_{GS} = 10\text{ V}, I_D = 7\text{ A}$ $V_{GS} = 4.5\text{ V}, I_D = 6\text{ A}$	N-Ch		19 24	28 40	m $\Omega$
		$V_{GS} = -10\text{ V}, I_D = -5\text{ A}$ $V_{GS} = -4.5\text{ V}, I_D = -4\text{ A}$	P-Ch		42 65	52 80	
$I_{D(on)}$	On-State Drain Current	$V_{GS} = 10\text{ V}, V_{DS} = 5\text{ V}$ $V_{GS} = -10\text{ V}, V_{DS} = -5\text{ V}$	N-Ch P-Ch	20 -20			A
$g_{FS}$	Forward Transconductance	$V_{DS} = 5\text{ V}, I_D = 7\text{ A}$ $V_{DS} = -5\text{ V}, I_D = -5\text{ A}$	N-Ch P-Ch		25 10		S
<b>Dynamic Characteristics</b>							
$C_{iss}$	Input Capacitance	N-Ch $V_{DS} = 15\text{ V}, V_{GS} = 0\text{ V}, f = 1.0\text{ MHz}$	N-Ch		575		pF
			P-Ch		528		
$C_{oss}$	Output Capacitance	P-Ch $V_{DS} = -15\text{ V}, V_{GS} = 0\text{ V}, f = 1.0\text{ MHz}$	N-Ch		145		pF
			P-Ch		132		
$C_{riss}$	Reverse Transfer Capacitance	$V_{DS} = -15\text{ V}, V_{GS} = 0\text{ V}, f = 1.0\text{ MHz}$	N-Ch P-Ch		65 70		pF
$R_G$	Gate Resistance	$V_{GS} = 15\text{ mV}, f = 1.0\text{ MHz}$	N-Ch		2.1		$\Omega$
			P-Ch		6.0		

**Electrical Characteristics (continued)**  $T_A = 25^\circ\text{C}$  unless otherwise noted

Symbol	Parameter	Test Conditions	Type	Min	Typ	Max	Units
<b>Switching Characteristics</b> (Note 2)							
$t_{d(on)}$	Turn-On Delay Time	N-Ch $V_{DD} = 15\text{ V}, I_D = 1\text{ A},$ P-Ch $V_{GS} = 10\text{ V}, R_{GEN} = 6\ \Omega$	N-Ch P-Ch		8 7	16 14	ns
$t_r$	Turn-On Rise Time		N-Ch P-Ch		5 13	10 24	ns
$t_{d(off)}$	Turn-Off Delay Time	P-Ch $V_{DD} = -15\text{ V}, I_D = -1\text{ A},$ N-Ch $V_{GS} = -10\text{ V}, R_{GEN} = 6\ \Omega$	N-Ch P-Ch		23 14	37 25	ns
$t_f$	Turn-Off Fall Time		N-Ch P-Ch		3 9	6 17	ns
$Q_g$	Total Gate Charge	N-Ch $V_{DS} = 15\text{ V}, I_D = 7\text{ A}, V_{GS} = 10\text{ V}$ P-Ch	N-Ch P-Ch		11.4 9.6	16 13	nC
$Q_{gs}$	Gate-Source Charge	P-Ch	N-Ch P-Ch		1.7 2.2		nC
$Q_{gd}$	Gate-Drain Charge	$V_{DS} = -15\text{ V}, I_D = -5\text{ A}, V_{GS} = -10\text{ V}$	N-Ch P-Ch		2.1 1.7		nC
<b>Drain-Source Diode Characteristics and Maximum Ratings</b>							
$I_S$	Maximum Continuous Drain-Source Diode Forward Current		N-Ch P-Ch			1.3 -1.3	A
$I_{SM}$	Maximum Pulsed Drain-Source Diode Forward Current (Note 2)		N-Ch P-Ch			20 -20	A
$V_{SD}$	Drain-Source Diode Forward Voltage	$V_{GS} = 0\text{ V}, I_S = 1.3\text{ A}$ (Note 2) $V_{GS} = 0\text{ V}, I_S = -1.3\text{ A}$ (Note 2)	N-Ch P-Ch		0.75 -0.88	1.2 -1.2	V
$t_{rr}$	Diode Reverse Recovery Time	N-Ch $I_F = 7\text{ A}, d_F/d_t = 100\text{ A}/\mu\text{s}$ P-Ch	N-Ch P-Ch		19 19		nS
$Q_{rr}$	Diode Reverse Recovery Charge	P-Ch $I_F = -5\text{ A}, d_F/d_t = 100\text{ A}/\mu\text{s}$ N-Ch	N-Ch P-Ch		9 6		nC

**Notes:**

- $R_{\theta JA}$  is the sum of the junction-to-case and case-to-ambient thermal resistance where the case thermal reference is defined as the solder mounting surface of the drain pins.  $R_{\theta JC}$  is guaranteed by design while  $R_{\theta CA}$  is determined by the user's board design.

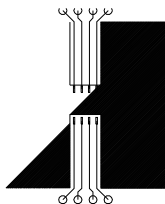

a) 78°/W when mounted on a 0.5 in<sup>2</sup> pad of 2 oz copper

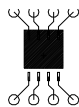

b) 125°/W when mounted on a .02 in<sup>2</sup> pad of 2 oz copper

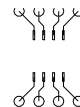

c) 135°/W when mounted on a minimum pad.

Scale 1 : 1 on letter size paper

- Pulse Test: Pulse Width < 300μs, Duty Cycle < 2.0%
- Starting  $T_J = 25^\circ\text{C}$ ,  $L = 3\text{ mH}$ ,  $I_{AS} = 6\text{ A}$ ,  $V_{DD} = 30\text{ V}$ ,  $V_{GS} = 10\text{ V}$  (Q1).
- Starting  $T_J = 25^\circ\text{C}$ ,  $L = 3\text{ mH}$ ,  $I_{AS} = 3\text{ A}$ ,  $V_{DD} = 30\text{ V}$ ,  $V_{GS} = 10\text{ V}$  (Q2).

Typical Characteristics: (N-Channel)

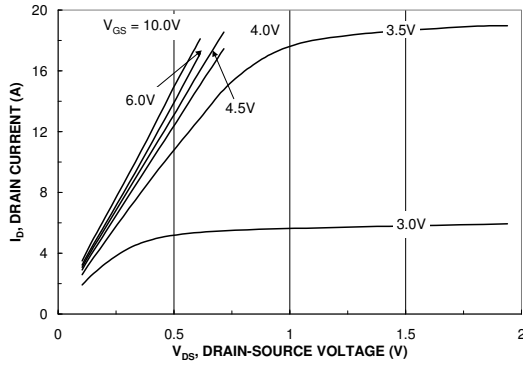

Figure 1. On-Region Characteristics.

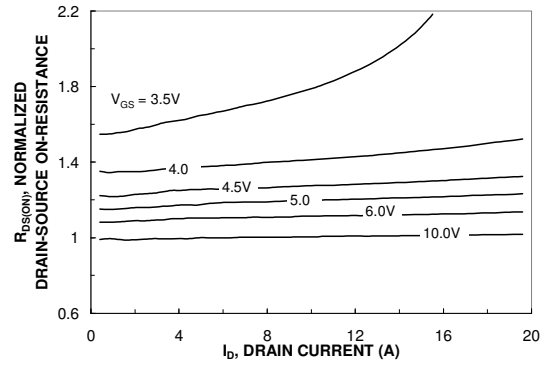

Figure 2. On-Resistance Variation with Drain Current and Gate Voltage.

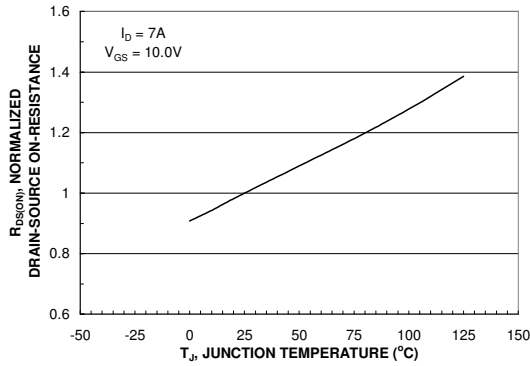

Figure 3. On-Resistance Variation with Temperature.

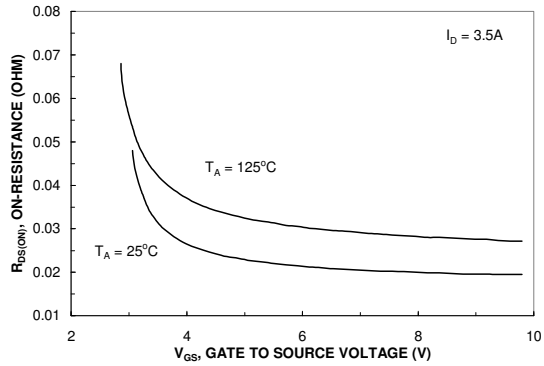

Figure 4. On-Resistance Variation with Gate-to-Source Voltage.

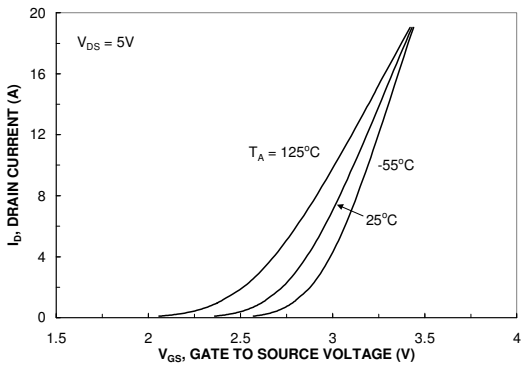

Figure 5. Transfer Characteristics.

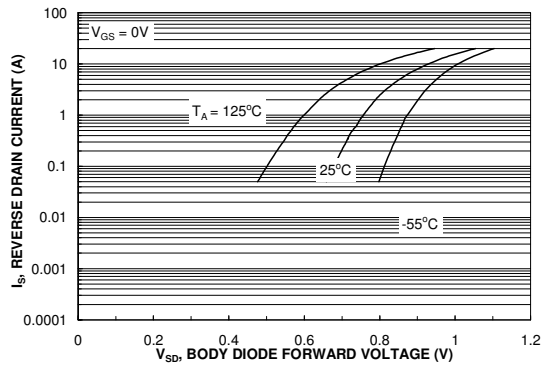

Figure 6. Body Diode Forward Voltage Variation with Source Current and Temperature.

Typical Characteristics: (N-Channel)

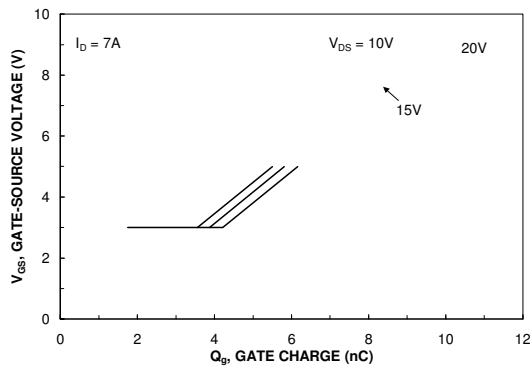

Figure 7. Gate Charge Characteristics.

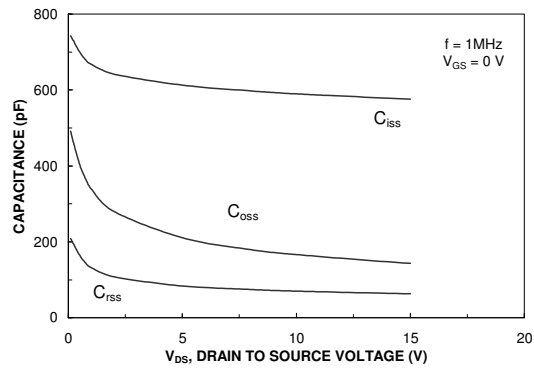

Figure 8. Capacitance Characteristics.

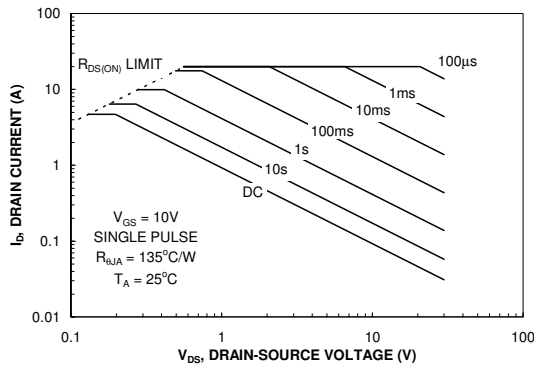

Figure 9. Maximum Safe Operating Area.

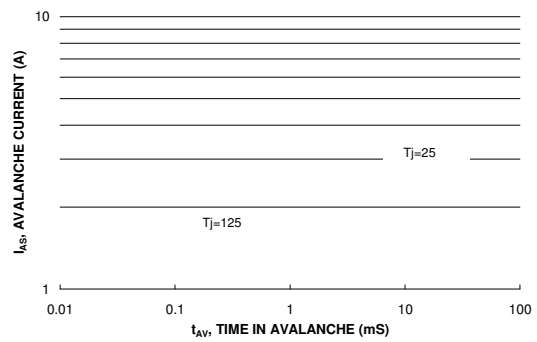

Figure 10. Unclamped Inductive Switching Capability Figure

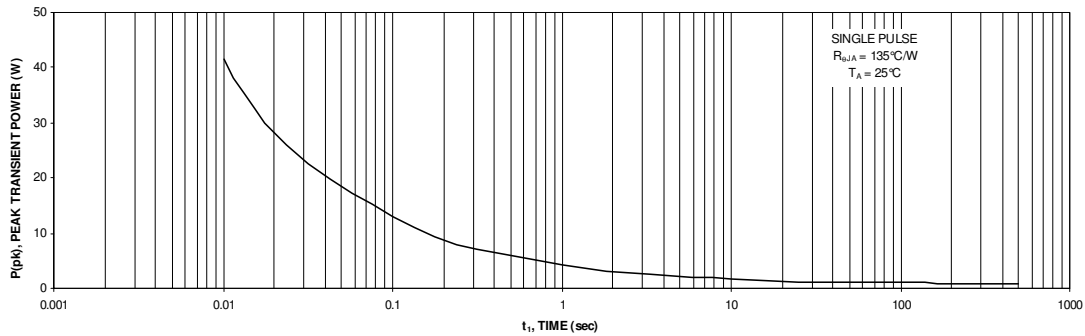

Figure 11. Single Pulse Maximum Power Dissipation.

Typical Characteristics: (P-Channel)

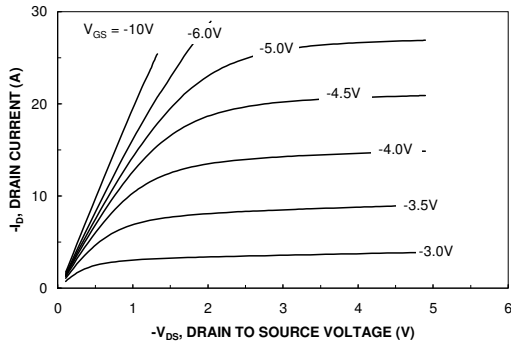

Figure 12. On-Region Characteristics.

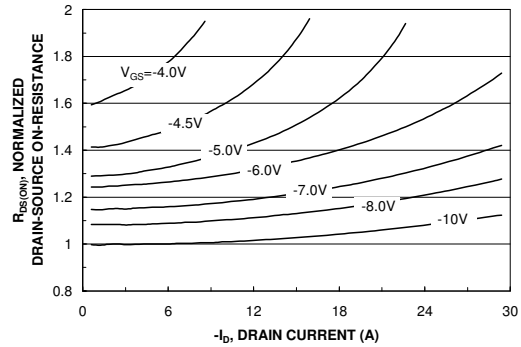

Figure 13. On-Resistance Variation with Drain Current and Gate Voltage.

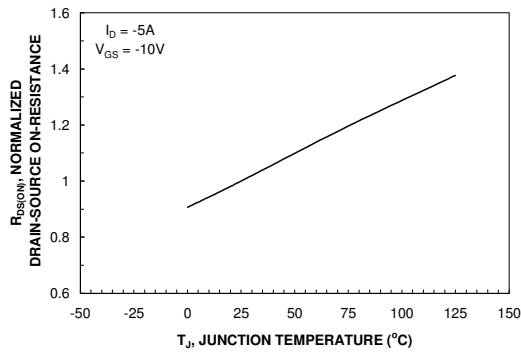

Figure 14. On-Resistance Variation with Temperature.

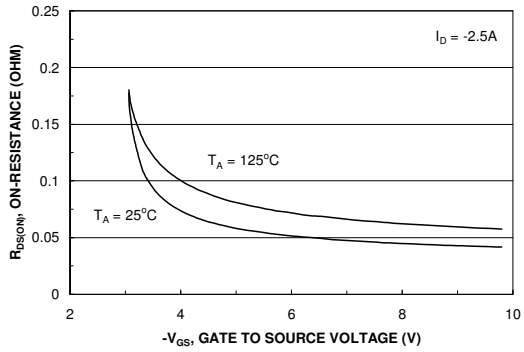

Figure 15. On-Resistance Variation with Gate-to-Source Voltage.

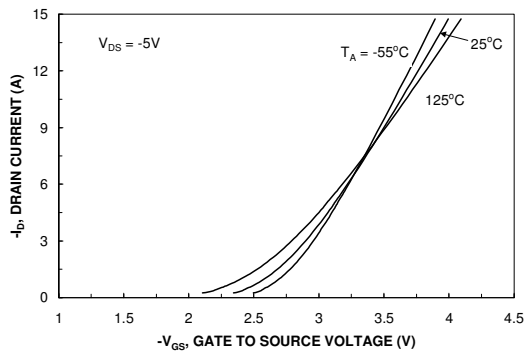

Figure 16. Transfer Characteristics.

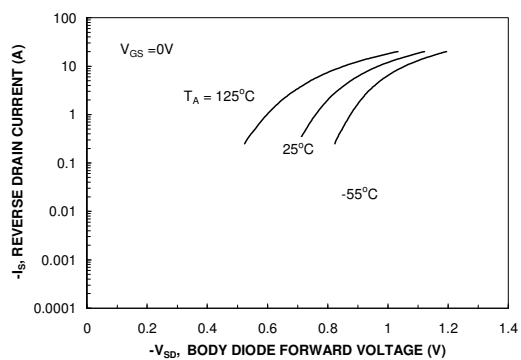
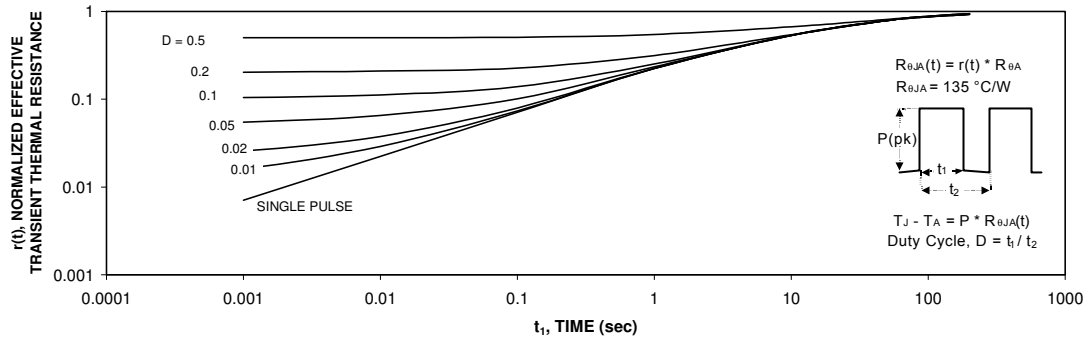

Figure 17. Body Diode Forward Voltage Variation with Source Current and Temperature.

Typical Characteristics: (P-Channel)



**Figure 23. Transient Thermal Response Curve.**

Thermal characterization performed using the conditions described in Note 1c. Transient thermal response will change depending on the circuit board design.

Package Mechanical Data SOP-8

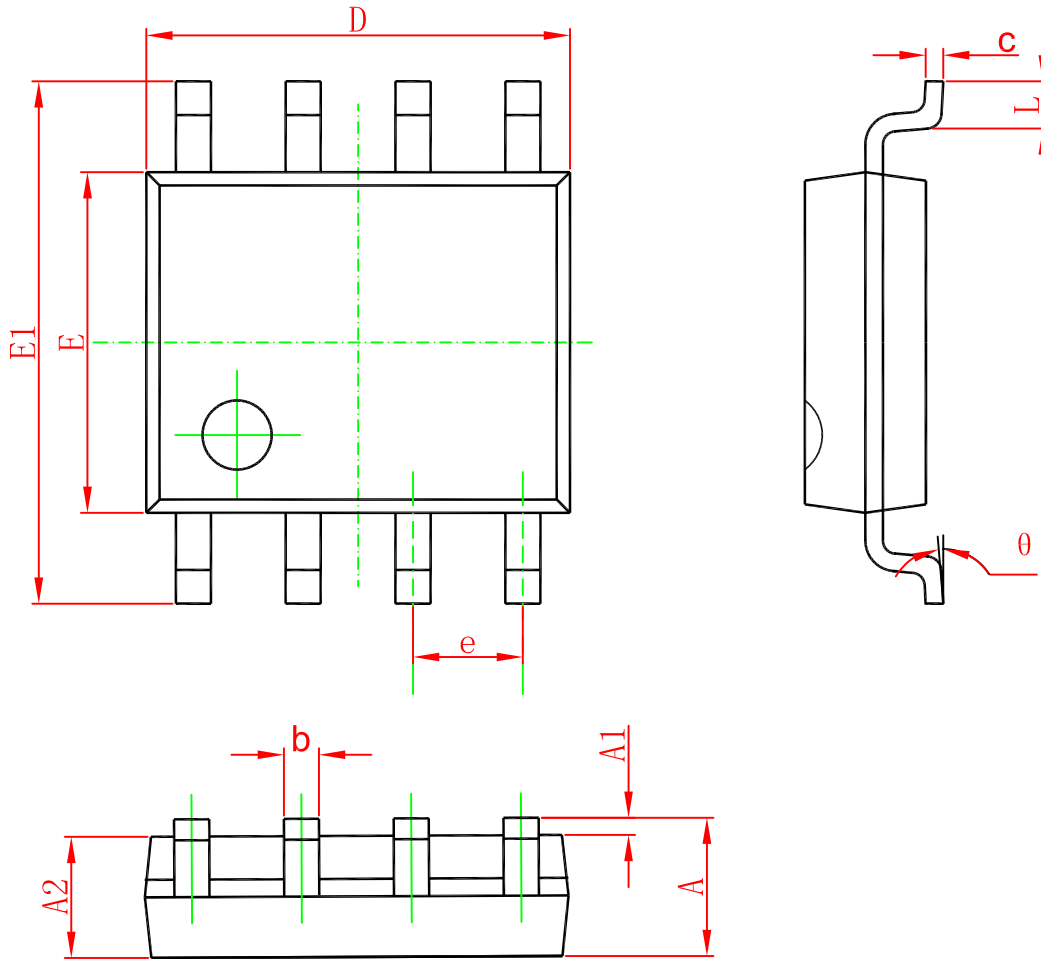

Symbol	Dimensions In Millimeters		Dimensions In Inches	
	Min	Max	Min	Max
A	1.350	1.750	0.053	0.069
A1	0.100	0.250	0.004	0.010
A2	1.350	1.550	0.053	0.061
b	0.330	0.510	0.013	0.020
c	0.170	0.250	0.006	0.010
D	4.700	5.100	0.185	0.200
E	3.800	4.000	0.150	0.157
E1	5.800	6.200	0.228	0.244
e	1.270(BSC)		0.050(BSC)	
L	0.400	1.270	0.016	0.050
theta	0°	8°	0°	8°



**Marking**

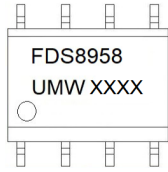

**Ordering information**

Order code	Package	Baseqty	Deliverymode
UMW FDS8958A	SOP-8	3000	Tape and reel